

SERVICE MANUAL
STEREO CASSETTE DECK
MODEL DT-41P

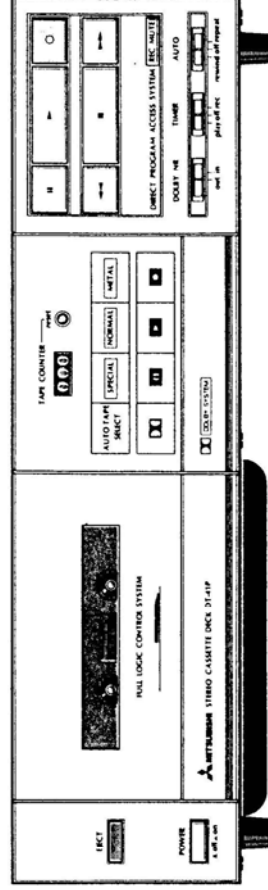

15052

CONTENTS

SPECIFICATIONS	2
DISMANTLING INSTRUCTIONS	3
ADJUSTMENT OF MECHANICAL SECTION	4
ADJUSTMENT OF ELECTRICAL SECTION	4
INTERNAL DIAGRAMS AND PINOUT OF INTEGRATED CIRCUITS	6
WIRING DIAGRAM	11
SCHEMATIC DIAGRAM	13
PRINTED CIRCUIT BOARDS	15
EXPLODED VIEW OF CABINET	17
EXPLODED VIEW OF MECHANISM	18
PARTS LIST	19
BLOCK DIAGRAM	22
PACKING INSTRUCTIONS	23

SPECIFICATIONS

Tape	4 track, 2 channel Stereo Cassette Deck
Motor type	
Capstan motor	.DC servo motor
Reel motor	.DC motor
Mechanism drive motor	.DC motor
Head material	
REC/PB head	.Hard permalloy
Erase head	.Ferrite
Tape speed	.4.75cm/s (1-7/8 ips)
Tape speed accuracy	±1%
Wow and flutter	.0.05% Wrms
Fast forward/rewind times	.115sec. (C-60 type)
SN ratio (400Hz, 3% THD, Weighted, Metal tape)	
Dolby NR out	.58dB (at 5 KHz)
Dolby NR in	.68dB (at 5 KHz)
Frequency response (Record level 160 pwb/mm -30dB)	
Normal tape	.20-15,000Hz
Special tape	.20-17,000Hz
Metal tape	.20-18,000Hz
Erasure ratio (1kHz)	.60dB (at 1 KHz)
Input sensitivity/impedance	
Line input	.150mV (120k ohms)
Bias frequency	.85 KHz
Output level	
Line output	.440mV (22k ohms load)
Power consumption	.16W
Dimensions (W x H x D)	.355 x 103 x 230 mm (14 x 4-1/16 x 9-1/16")
Weight	.3.9kg (8.6 lbs)

Noise Reduction System manufactured under license from Dolby Laboratories Licensing Corporation.
'Dolby' and the double-D symbol are trademarks of Dolby Laboratories Licensing Corporation.
Specifications of this unit are subject to change without notice for improvement.

DISMANTLING INSTRUCTIONS

1. REMOVAL CASE

- 1) Remove six screws (SCREW-METAL 3 x 8) fixing the case and slide the case backward for removal. (See Fig. 1)

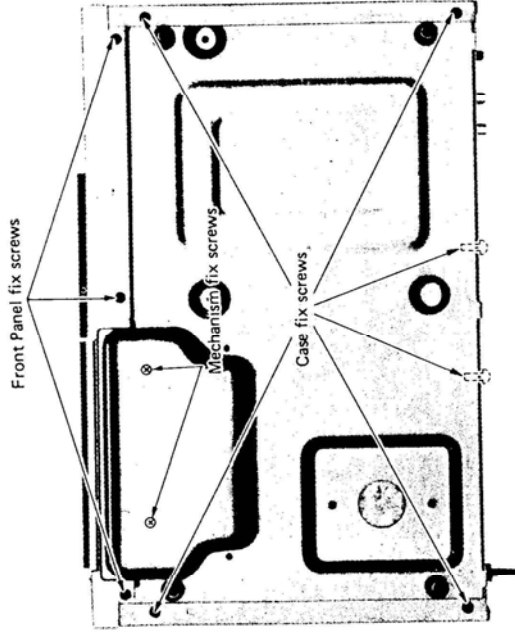

Fig. 1

2. FRONT PANEL REMOVAL

- 1) Remove the case according to the procedure of 1.
- 2) Remove the cassette case.
- 3) Remove front panel fixing screws (two 2-3 x 8 on the top, one 2-3 x 6 on the top and three 2-3 x 6 on the bottom). Front panel can be removed together with the SWITCH PC board. (See Figs. 1 and 2)
- 4) Remove one screw 1-2.6 x 6 fixing the SWITCH PC board. PC board can now be disassembled from the panel.

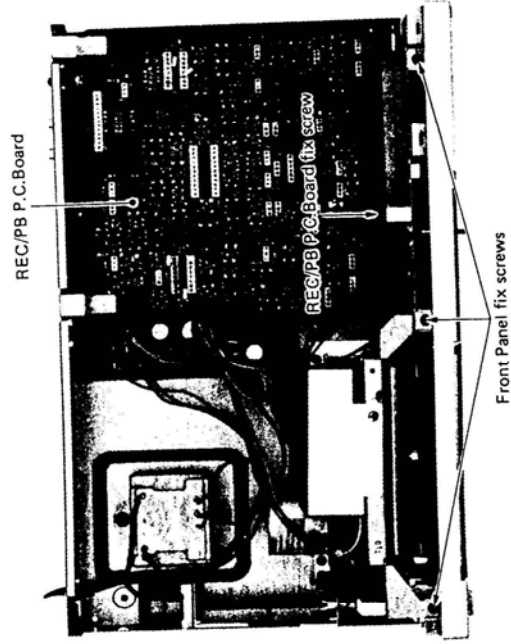

Fig. 2

3. MECHANISM REMOVAL

- 1) Remove the case and front panel according to the procedure of 1 and 2.
- 2) Take off the counter belt from the counter side.
- 3) Remove five screws (2-3 x 6) fixing the mechanism assembly. (See Figs. 3 and 4) (Fig. 1)
- 4) Remove one screw 2-3 x 8 fixing the RECORD PC board. Raise the PC board and disconnect jacks J110, J140, and 510 and jacks J920 and 921 of MECHANISM CONTROL PC board. The mechanism assembly can be removed.

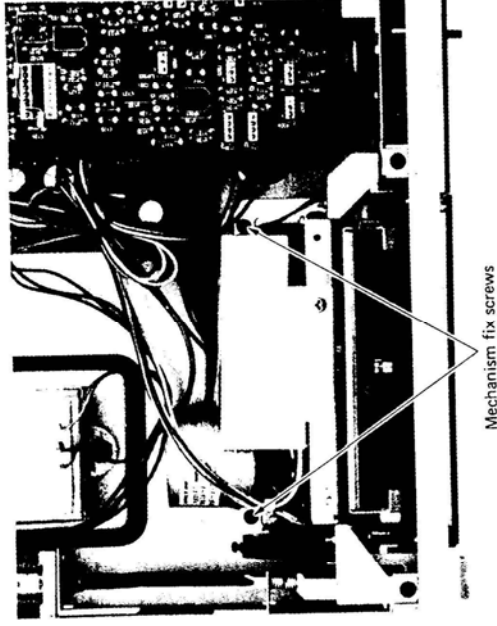

Fig. 3

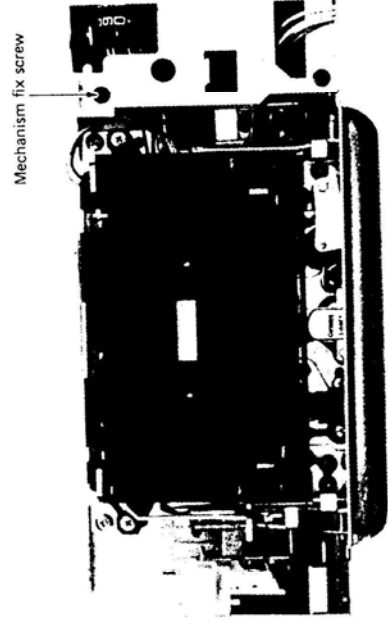

Fig. 4

ADJUSTMENT OF MECHANICAL SECTION

1. ADJUSTING THE TAPE SPEED

- 1) Setting — Connect a frequency counter to the output terminal.
- 2) Test tape — MTT-111 (3 kHz)
- 3) Adjustment procedure — Play back the test tape, and insert a standard screwdriver into the motor adjusting hole and adjust till the frequency counter indicates 3000 Hz.

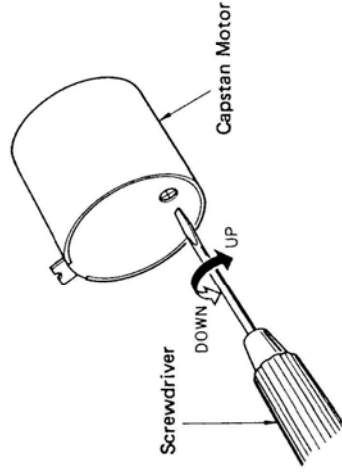
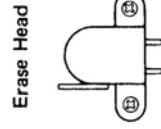

Fig. 5

2. ADJUSTING THE HEAD ANGLE

- 1) Setting Set the PLAY-BACK OUTPUT LEVEL ADJUSTMENT preset control VR102 (L), VR202 (R) to the max. level.
- 2) Test tape MTT-215C (10k/315Hz, -10 dB, NORMAL)
- 3) Location of adjustment Head angle adjusting screw
- 4) Adjustment procedure Play back the test tape and adjust for maximum output on both channels.



Erase Head

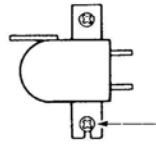

REC/PB Head

Head Azimuth Adj. Screw

Fig. 6

ADJUSTMENT OF ELECTRICAL SECTION

MEASURING INSTRUMENTS AND TEST TAPES

1. Low-frequency oscillator 20 Hz — 20 kHz
2. Variable resistance attenuator 0 — 90 dB, 0.1 or 0.5 dB step
3. AC voltmeter Measuring range of 20 Hz — 200 kHz or more, input impedance more than 100 k Ω , and -60 dB or more
4. Frequency counter
5. Oscilloscope
6. Test tape
 - MTT-111 (3 kHz)
 - MTT-215C (10K/315 Hz, -10dB, NORMAL)
 - MTT-150 (400Hz dolby level)
 - AC-512 (blank)

7. How to connect the instrument

- 1) Connect a load resistance 22 k Ω , then the AC voltmeter and oscilloscope to the output terminal of deck.
- 2) To adjust the recording system, connect the low-frequency oscillator and resistance attenuator to the input terminal of deck.

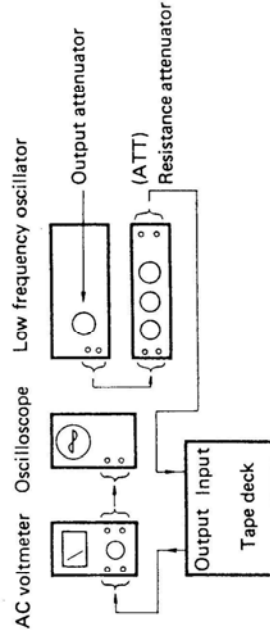

ADJUSTMENT OF PLAY-BACK SYSTEM

1. ADJUSTING THE PLAY-BACK OUTPUT LEVEL

- 1) Test tape MTT-150 (Dolby level)
- 2) Location for adjustment Preset control VR102 (L), VR202 (R)
- 3) Location of detection (+) side of electrolytic capacitor C129 (L), C229 (R)
- 4) Adjustment procedure Playback the test tape and adjust until the output level on the (+) side of C129 and C229 becomes 580 mV \pm 0.25 dB.

2. ADJUSTING THE MPX FILTER

- 1) Setting With the deck kept in the specified recording condition, stop the bias oscillator.

- 2) Location of adjustment FL101 (L), FL201 (R)
- 3) Adjustment procedure Apply a 19kHz signal to the input terminal and adjust FL101 and FL201 for minimum output level.

- 2) Test tape AC-512
- 3) Location of adjustment Preset control VR301 (L), VR401 (R)

- 4) Adjustment procedure Adjust so that the output level for recording and play-back of 400 Hz signal is equal to the level for monitoring.

ADJUSTMENT OF RECORDING SYSTEM

1. ADJUSTING THE BIAS FREQUENCY

- 1) Setting Connect the frequency counter to pin 1 (L) and pin 3 (R), J120.
- 2) Location of adjustment T501
- 3) Adjustment procedure Adjust until the frequency counter indicates 85 kHz.

3. ADJUSTING THE BIAS CURRENT

- 1) Setting Same as for the adjustment of recording current described in 2.

- 2) Test tape AC512
- 3) Location of adjustment Preset control VR-501 (L), VR502 (R)

- 4) Adjustment procedure

2. ADJUSTING THE RECORDING CURRENT

- 1) Setting With the deck in a recording state, apply a 400 Hz, -10dB signal. Adjust the RECORDING LEVEL CONTROL control until a -7 dB output is obtained at the output terminal. Then lower the input level by 30 dB.

- 4) Adjustment procedure Adjust so that the level difference of 8 kHz to 400 Hz is $+0.5\text{dB}$, -0dB when recording and play-back 400 Hz and 8 kHz signals.

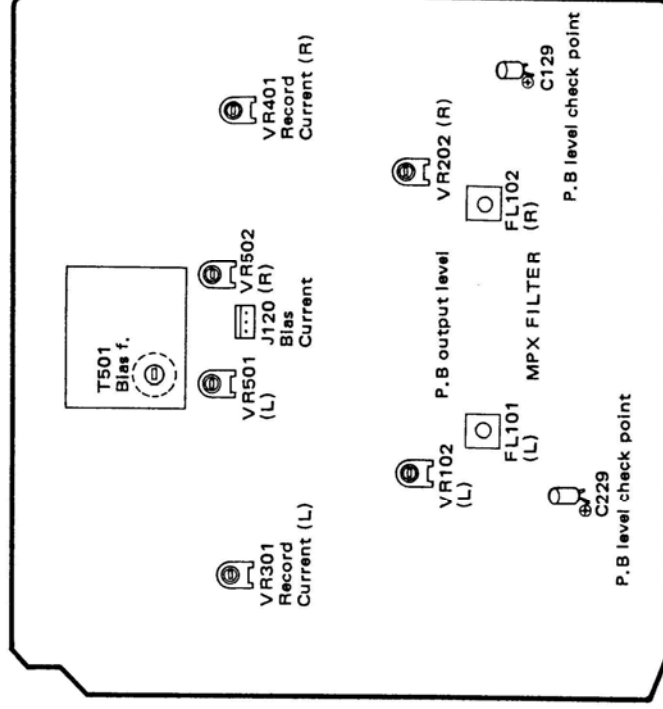

INTERNAL DIAGRAMS AND PINOUT OF INTEGRATED CIRCUITS

IC101: M51125P

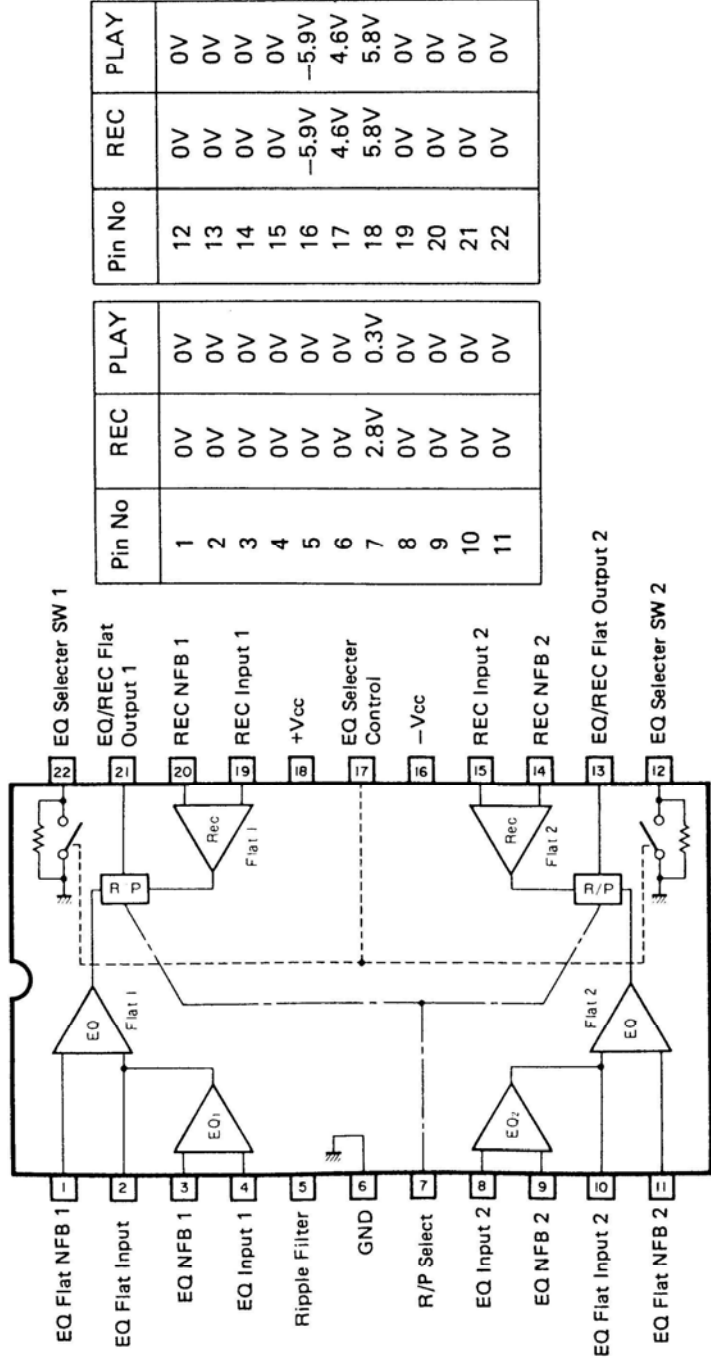

Pin No	REC	PLAY	Pin No	REC	PLAY
1	0V	0V	12	0V	0V
2	0V	0V	13	0V	0V
3	0V	0V	14	0V	0V
4	0V	0V	15	0V	0V
5	0V	0V	16	-5.9V	-5.9V
6	0V	0V	17	4.6V	4.6V
7	2.8V	0.3V	18	5.8V	5.8V
8	0V	0V	19	0V	0V
9	0V	0V	20	0V	0V
10	0V	0V	21	0V	0V
11	0V	0V	22	0V	0V

IC102, 202: TA7629P
Dolby B-NR

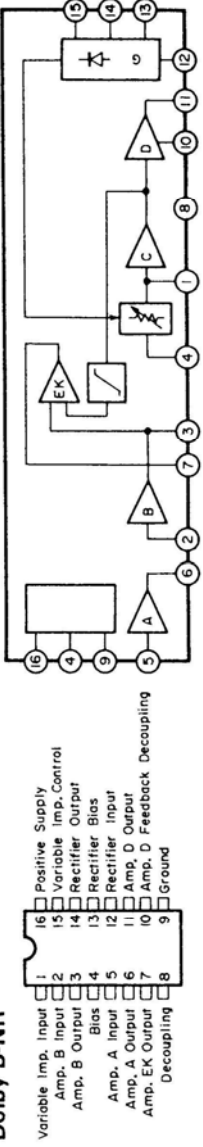

IC902: MB4204
Comparator

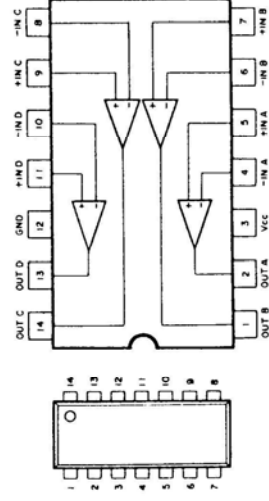

● COMPARATOR



Mode	Pin No.	1	2	3	4	5	6	7	8	9	10	11	12	13	14
PLAY	1	4.1V	4.1V	Vcc	3.0V	4.9V	4.9V	4.9V	4.9V	3.0V	0.6V	0.6V	GND	5.3V	4.2V
	2	4.1V	4.1V	Vcc	3.0V	4.9V	4.9V	4.9V	4.9V	3.0V	0.6V	0.6V	-	5.3V	4.2V
REC	1	4.1V	4.1V	Vcc	3.0V	4.9V	4.9V	4.9V	4.9V	3.0V	0.5V	0.5V	-	4.5V	4.2V
	2	4.1V	4.1V	Vcc	3.0V	4.9V	4.9V	4.9V	4.9V	3.0V	0.5V	0.5V	-	4.3V	4.2V
REW	1	4.1V	4.1V	9.4V	3.0V	4.9V	4.9V	4.9V	4.9V	3.0V	0 V	0 V	-	5.5V	4.2V
	2	4.1V	4.1V	10.4V	3.0V	4.9V	4.9V	4.9V	4.9V	3.0V	0 V	0 V	-	5.5V	4.2V
STOP	1	4.1V	4.1V	Vcc	3.0V	4.9V	4.9V	4.9V	4.9V	3.0V	0 V	0 V	-	5.5V	4.2V
	2	4.1V	4.1V	Vcc	3.0V	4.9V	4.9V	4.9V	4.9V	3.0V	0 V	0 V	-	5.5V	4.2V
PAUSE	1	4.1V	4.1V	Vcc	3.0V	4.9V	4.9V	4.9V	4.9V	3.0V	0.5V	0.5V	-	4.5V	4.2V
	2	4.1V	4.1V	Vcc	3.0V	4.9V	4.9V	4.9V	4.9V	3.0V	0.5V	0.5V	-	4.5V	4.2V
FWD	1	3.4V	4.1V	Vcc	3.0V	4.9V	4.9V	4.9V	4.9V	3.0V	0.5V	0.5V	-	4.4V	4.2V
	2	4.1V	4.1V	9.3V	3.0V	4.9V	4.9V	4.9V	4.9V	3.0V	0.5V	0.5V	-	4.4V	4.2V
REV	1	4.1V	4.1V	Vcc	3.0V	4.9V	4.9V	4.9V	4.9V	3.0V	0.5V	0.5V	-	4.4V	4.2V
	2	4.1V	4.1V	Vcc	3.0V	4.9V	4.9V	4.9V	4.9V	3.0V	0.5V	0.5V	-	4.4V	4.2V

● Vcc...8.6V

IC901:MB884-584K MICROPROCESSOR (MECHANISM CONTROL)

TERMINAL DESCRIPTION OF MECHANISM CONTROL IC

Pin No.	Pin nomenclature	Function		
1	Extal	-	IN	<ul style="list-style-type: none"> • Clock (3MHz) • 1/2 branched inside to be used as a basic clock (instruction execution time 4MS/STEP)
2	Xtal	-	OUT	
3	<u>RESET</u>	<u>RESET</u>	IN	<ul style="list-style-type: none"> • Internal initialized with "L" to allow program execution start from an address "0".
4	IRO	TAPE END S. IN.	IN	<ul style="list-style-type: none"> • Interruption handling with "L" to count the number of pulses. • With the interruption handling unexecuted for the second, the end stop function is actuated (in the TAPE RUN mode).
5	SO	BLANK	OUT	Blank
6	SI	BLANK	IN	Blank
7	<u>SC/TO</u>	BLANK	IN, OUT	Blank
8	TC	BLANK	IN	Blank
9	P ₀	DA ₀	OUT	<ul style="list-style-type: none"> • D/A control output to produce comparison voltage for key interruption • Output in BCD code. One cycle completed in "F" → "D" → "8" → "9" → "7" → "5" → "3" → "1"
10	P ₁	DA ₁	OUT	
11	P ₂	DA ₂	OUT	
12	P ₃	DA ₃	OUT	
13	O ₀	MPSS Z ₀	OUT	<ul style="list-style-type: none"> • MPSS set number of skip selection programs/operation display. • Output in BCD code: codes "0" - "8" and "F" used.
14	O ₁	MPSS Z ₁	OUT	
15	O ₂	MPSS Z ₂	OUT	
16	O ₃	MPSS Z ₃	OUT	<ul style="list-style-type: none"> • Output signal for REC OUT (R_s Zrpin) and R/P change-over. • "L" in REC.
17	O ₄	<u>HEAO</u> CONT.	OUT	
18	O ₅	<u>BIAS OSC</u> CONT.	OUT	<ul style="list-style-type: none"> • Output signal for ON/OFF of bias oscillation circuit. • "L" in REC PLAN, REC/PLAY/ASPS.
19	O ₆	REC MUTE.	OUT	<ul style="list-style-type: none"> • Output signal for REC MUTE • "H" in MUTE;
20	O ₇	PLAY BACK MUTE	OUT	<ul style="list-style-type: none"> • Output signal for PLAY BACK MUTE (LINE MUTE) • "H" in MUTE.
21	V _{SS}	GND	-	<ul style="list-style-type: none"> • Ground of power supply.

22	R ₀	CAM M. OUT 1	OUT	<ul style="list-style-type: none"> • Cam motor control output signal. • R₀ = "L" and R₁ = "H" output at early stage of power supply application for positioning of stop.
23	R ₁	CAM M. OUT 1	OUT	
24	R ₂	REEL M. OUT 0	OUT	<ul style="list-style-type: none"> • Reel motor control output signal. • R₂ = "L", R₃ = "H" output during play.
25	R ₃	REEL M. OUT 2	OUT	
26	R ₄	PLAY OUT	OUT	<ul style="list-style-type: none"> • Output signal (for display) turning into "L" at PLAY.
27	R ₅	REC OUT	OUT	<ul style="list-style-type: none"> • Output signal (for display) turning into "L" at REC. • Used, together with HEAD CONT (O4 17p/n), for R/P change-over.
28	R ₆	PAUSE OUT	OUT	<ul style="list-style-type: none"> • Output signal (for display) turning into "L" at PAUSE.
29	R ₇	ASPS OUT	OUT	<ul style="list-style-type: none"> • Output signal (for display) turning into "L" at ASPS.
30	R ₈	SHORT R. OUT	OUT	<ul style="list-style-type: none"> • Control output signal turning into "L" during SHORT REPEAT function. • AMP gain change-over signal for MPSS (MSS).
31	R ₉	VOLT OUT	OUT	<ul style="list-style-type: none"> • Reel motor voltage control output signal. • "L" at FF/REC, FWD/REV for change-over to high voltage.
32	R ₁₀	CAPS M. OUT	OUT	<ul style="list-style-type: none"> • Capstan motor control output signal. • "L" at PLAY or PAUSE for motor running.
33	R ₁₁	MPSS OUT	OUT	<ul style="list-style-type: none"> • Output signal turning into "L" at program selection of MPSS (MSS).
34	R ₁₂	MPSS IN	IN	<ul style="list-style-type: none"> • "H" (between programs) and "L" (within program) are input for control of heading.
35	R ₁₃	MEMORY IN	IN	<ul style="list-style-type: none"> • Memory function goes ON with . • ON with  only for MEMORY SHORT REPEAT.
36	R ₁₄	ANTI REC IN	IN	<ul style="list-style-type: none"> • Recording preventive input signal. • "L" input to prevent recording.
37	R ₁₅	PLAY POS.	IN	<ul style="list-style-type: none"> • Head base PLAY position input signal. • "L" input only at PLAY position.
38	K ₀	K ₀ IN	IN	<ul style="list-style-type: none"> • Signal input terminal of switches, STOP, PLAY, FWD, and TIMER REC/PLAY. • ON/OFF judgement with code value of DA₀ - DA₃
39	K ₁	K ₁ IN	IN	<ul style="list-style-type: none"> • Signal input terminal of switches, REC, FF, REW, MPSS RESET, MPSS SET, and SPEED TEST. • ON/OFF judgement with code value of DA₀ - DA₃
40	K ₂	K ₂ IN	IN	<ul style="list-style-type: none"> • Signal input terminal of switches, PAUSE, REW, ASPS, and AUTO REPEAT/REW/PLAY. • ON/OFF judgement with code value DA₀ - DA₃
41	K ₃	O. POS.	IN	<ul style="list-style-type: none"> • Position input signal, which is "L" at each position (STOP, FF/REW, PAUSE, PLAY) of head base.
42	V _{cc}	= 5V		<ul style="list-style-type: none"> • ± 5V power supply

Next Mode	1 Input STOP	1 Input FF	1 Input REW	1 Input PLAY	1 Input PAUSE	2 Input REC/ PAUSE	2 Input REC/ PLAY	3 Input REC/ PLAY/ ASPS	1 Input REC/	1 Input ASFRS	1 Input (MPSS) (MSS) REV	1 Input (MPSS) (MSS) FWD	Note2) (MPSS) (MSS) PLAY
STOP	→	FF (1)	REW (2)	PLAY (3)	PAUSE (4)	REC/ PAUSE/ (5)	REC/ PLAY/ (6)	REC/ PLAY/ ASPS/ (7)	→	→	REV (8)	FWD (9)	
FF	STOP (10)	→	REW (11)	PLAY (12)	→	→	• REC/ PLAY (13)	• REC/ PLAY/ ASPS/ (14)	→	→	REV (15)	FWD (16)	
REW	STOP (17)	FF (18)	→	PLAY (19)	→	→	• REC/ PLAY/ (20)	• REC/ PLAY/ ASPS/ (21)	→	→	REV (22)	FWD (23)	
PLAY (MPSS) (MSS)	▲ STOP (24)	FF (25)	REW (26)	→	▲ PAUSE (27)	▲ REC/ PAUSE/ (28)	REC/ PLAY (29)	REC/ PLAY/ ASPS (30)	→	→	REV (31)	FWD (32)	
PAUSE	STOP (33)	FF (34)	REW (35)	PLAY (36)	→	REC/ PAUSE/ (37)	REC/ PLAY/ (38)	REC/ PLAY/ ASPS/ (39)	→	→	Note 1) REV (40)	FWD (41)	
REC/ PAUSE	STOP (42)	FF (43)	REW (44)	REC/ PLAY (45)	→	→	REC/ PLAY/ (46)	REC/ PLAY/ ASPS/ (47)	→	→	• REV (48)	FWD (49)	
REC/ PLAY	▲ STOP (49)	FF (50)	REW (51)	→	▲ REC/ PAUSE/ (52)	▲ REC/ PAUSE (53)	→	REC/ PLAY/ ASPS/ (54)	→	REC/ PLAY/ ASPS/ (93)	• REC (55)	FWD (56)	
REC/ PLAY/ ASPS	▲ STOP (56)	FF (57)	REW (58)	REC/ PLAY/ (59)	▲ REC/ PAUSE/ (60)	▲ REC/ PAUSE (61)	REC/ PLAY/ (62)	→	→	→	• REV (63)	FWD (64)	
(MPSS) (MSS) REV	STOP (63)	FF (64)	REW (65)	PLAY (66)	PAUSE (67)	→	• REC/ PLAY/ (68)	• REC/ PLAY/ ASPS/ (69)	→	→	→	FWD (70)	• (MPSS) (MSS) PLAY (66)
(MPSS) (MSS)	STOP (72)	FF (73)	REW (74)	PLAY (76)	PAUSE (76)	→	• REC/ PLAY/ (77)	• REC/ PLAY/ ASPS/ (78)	→	→	REC (78)	→	• (MPSS) (MSS) PLAY (75)

- ▲ — Rewinding
- — Function via stop
- — Indicates continuation of current mode
- — No combination
- X — No combination

Note 1) When PAUSE → REV → FWD is effectuated, PAUSE state is obtained in the order of a selected program and a next program.
 Note 2) This state is a short repeat (repetition of one program) function set only within the mechanical control.

IC903, 904: BA6208
Reel Motor
Cam Motor Drive

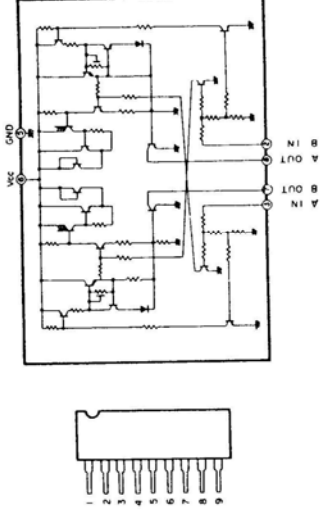

● **DRIVE VOLTAGE (REEL MOTOR)**

Mode	Pin No.	1	2	3	4	5	6	7	8	9
STOP		10.5V	2.8V	2.8V	0V	0V	5.7V	0V	0V	0V
PLAY		8.8V	3.1V	0V	0V	0.7V	5.6V	4.6V	0.9V	0V
FF		9.3V	3.1V	0V	0V	0.5V	8.4V	7.5V	0.6V	0V
REW		9.4V	0V	3.0V	0V	0.5V	8.4V	0.6V	7.5V	0V

● **TRUTH TABLE**

A IN	B IN	B OUT	A OUT	Motor
1	1	L	L	Short
1	0	H	L	+
0	2	L	H	-
0	0	-	-	Open

IC905: M54527P
Interface

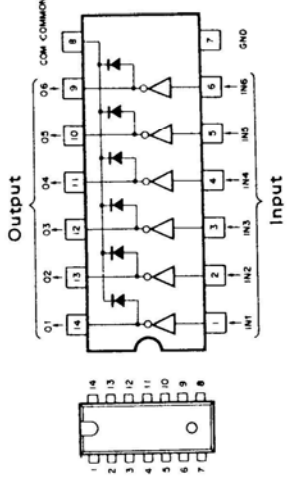

WIRING DIAGRAM

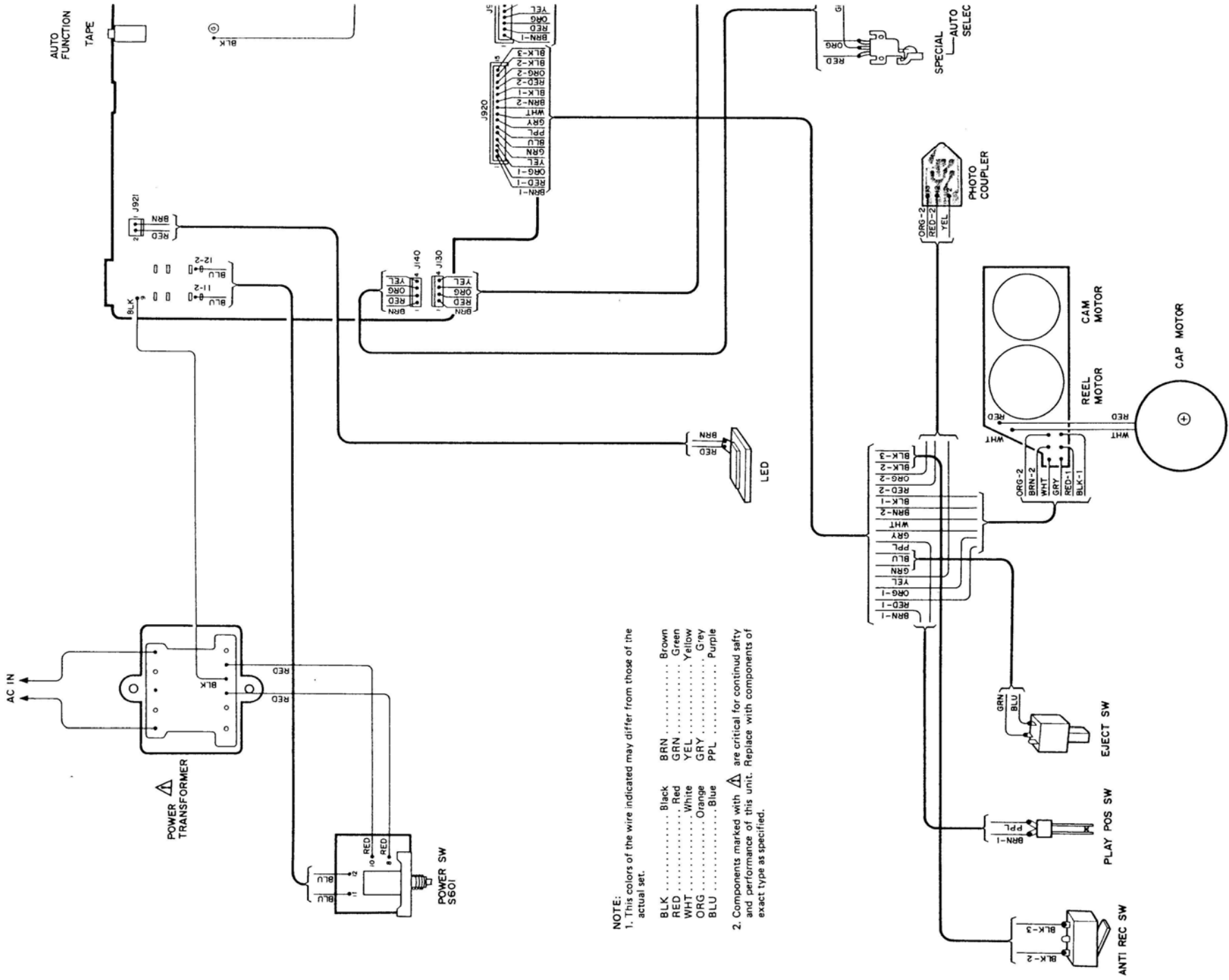

NOTE:
 1. This color of the wire indicated may differ from those of the actual set.

- BLK Black
- BRN Brown
- RED Red
- GRN Green
- WHT White
- YEL Yellow
- ORG Orange
- GRY Grey
- BLU Blue
- PPL Purple

2. Components marked with Δ are critical for continued safety and performance of this unit. Replace with components of exact type as specified.

DT-41P

DT-41P

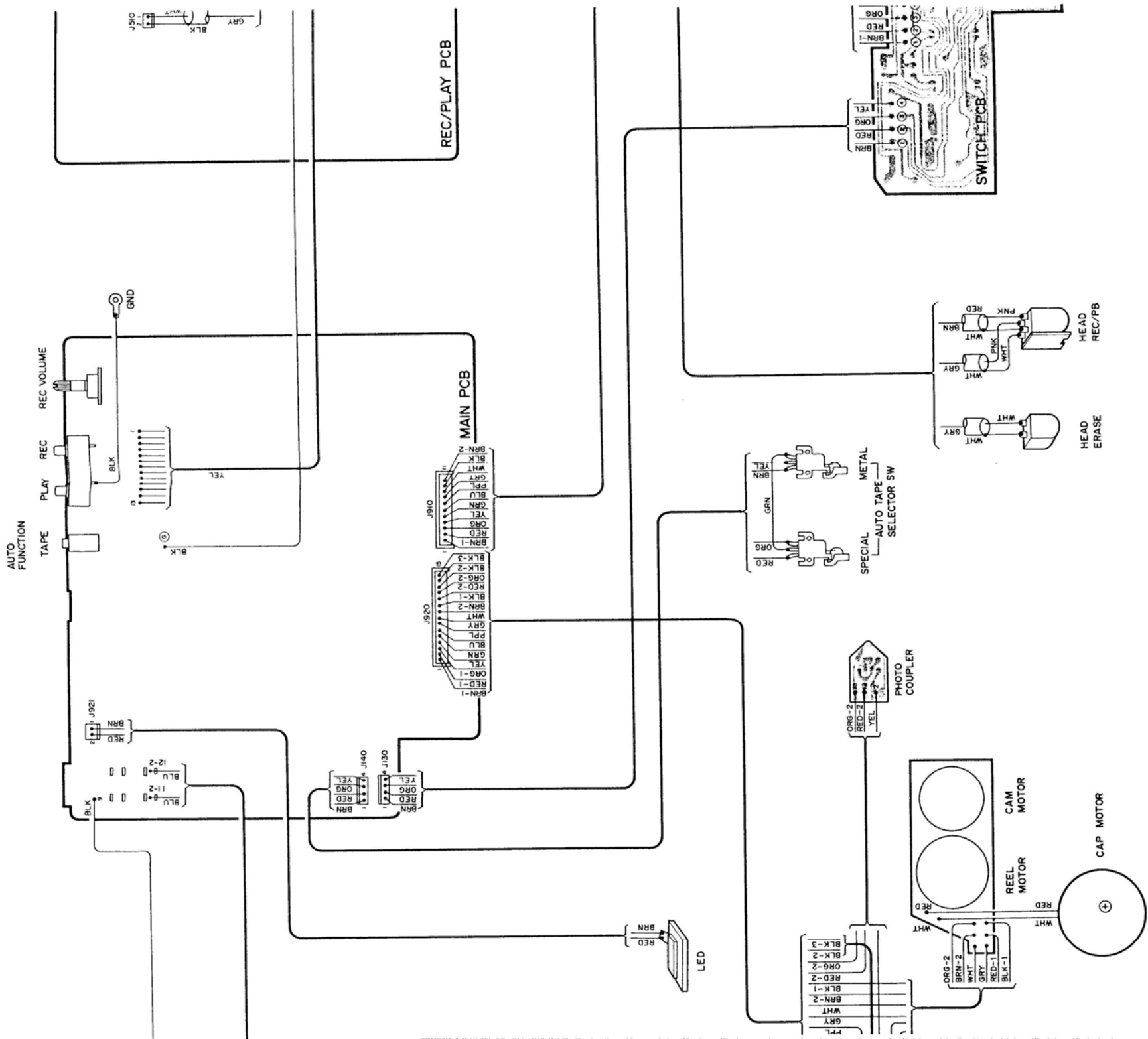

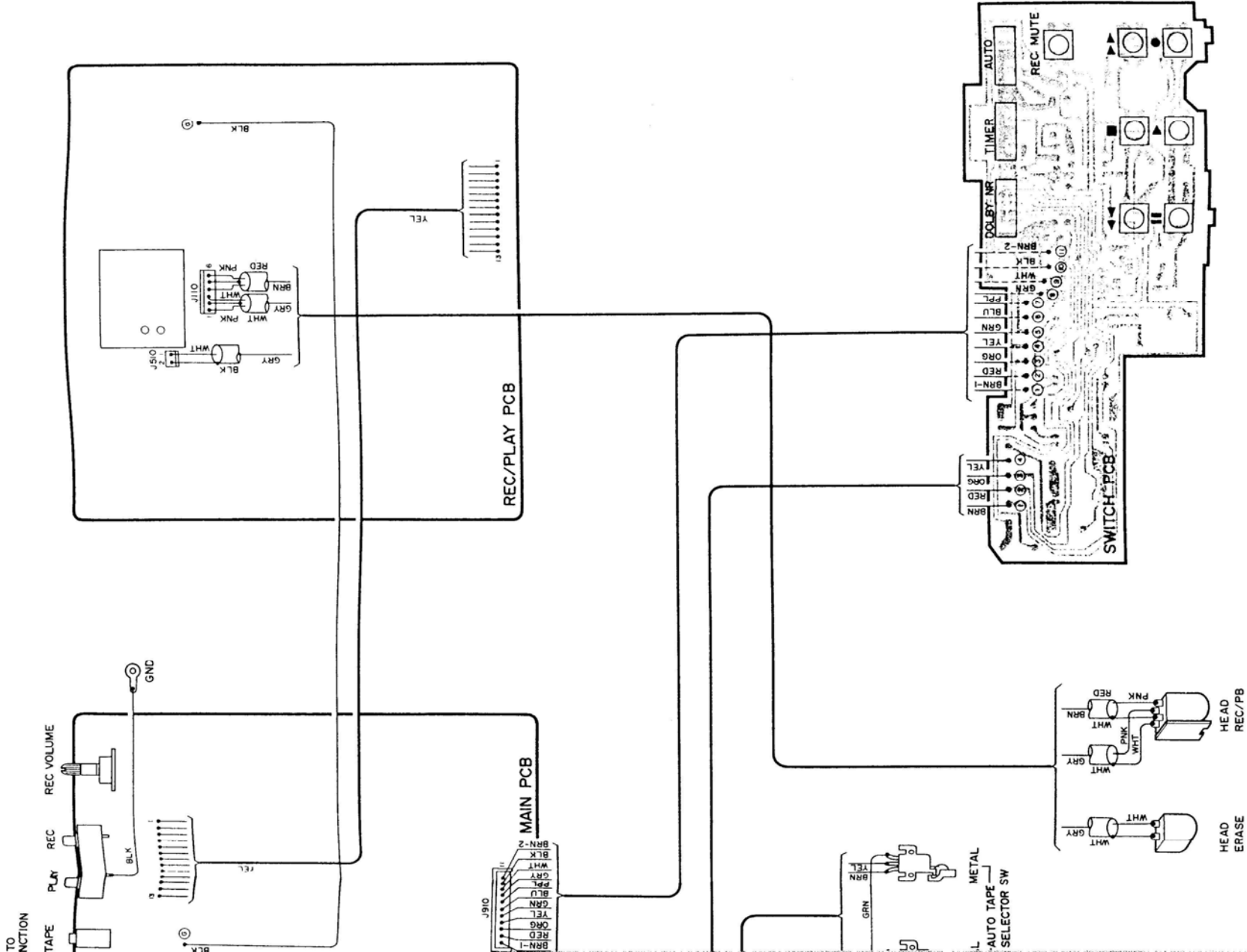

SCHEMATIC DIAGRAM

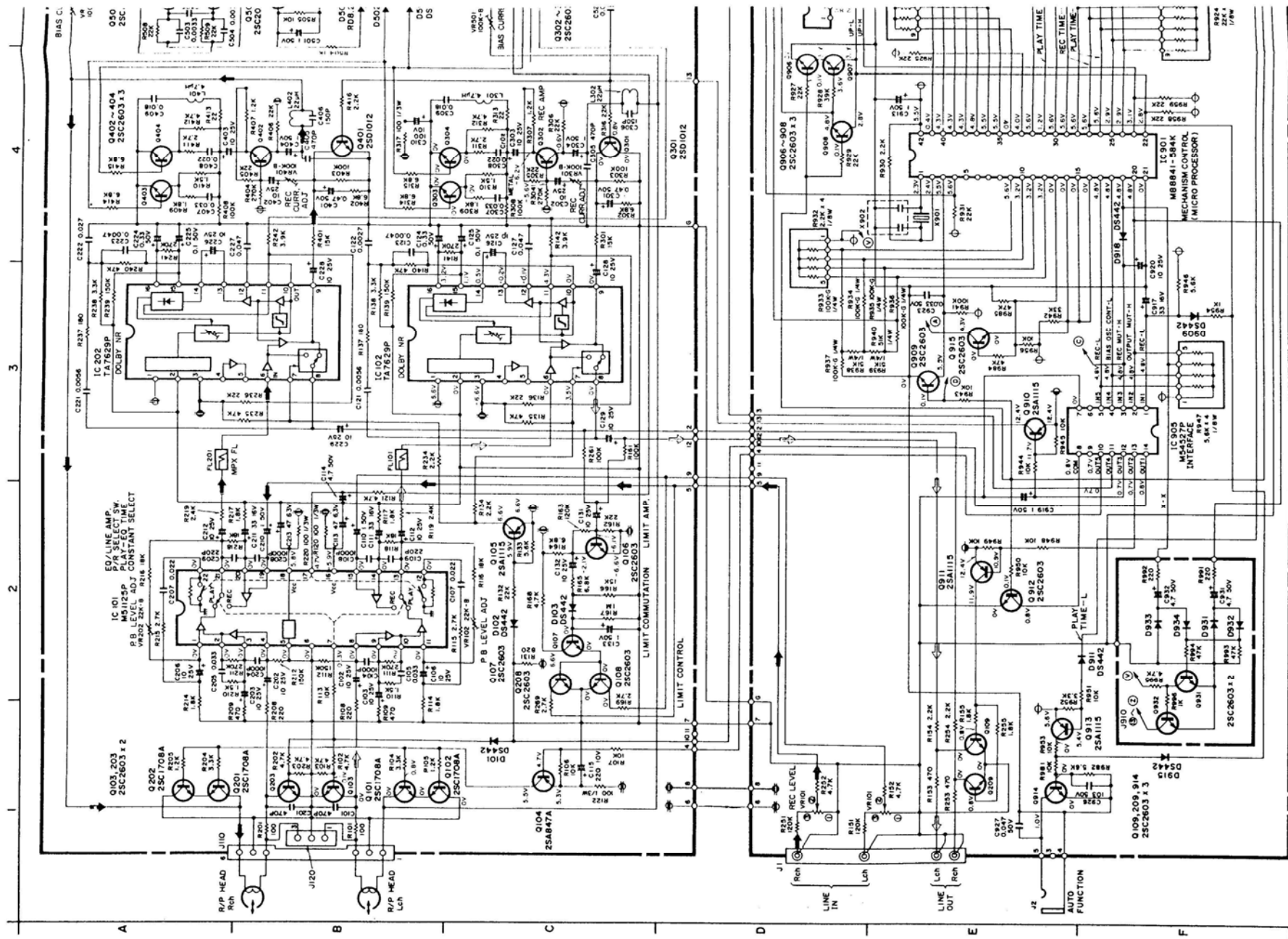

DT-41P

DT-41P

3 4 5 6 7

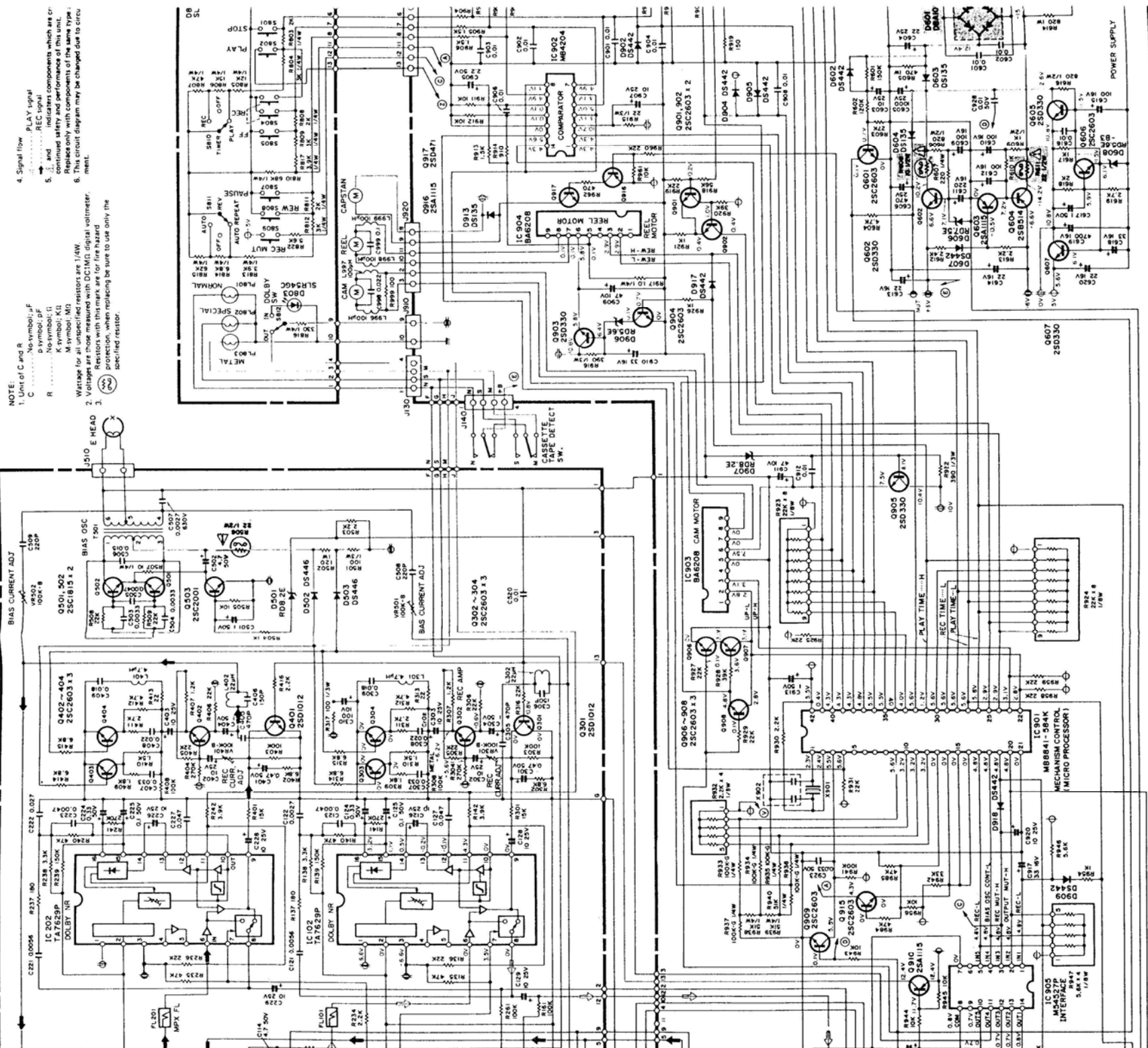

NOTE:

1. Unit of C and R
2. Voltage for all unspecified resistors is 1/8W
3. Protection, when replacing be sure to use only the specified resistor.
4. Signal flow
5. and indicates components which are continued safety and performance of this unit.
6. The circuit diagram may be changed due to circuit.

- No symbol: μ F
- No symbol: pF
- No symbol: Ω
- No symbol: K
- No symbol: M
- No symbol: KI
- No symbol: MI

- Resistors with this mark are for fire hazard
- Resistors with this mark are for fire hazard
- Resistors with this mark are for fire hazard

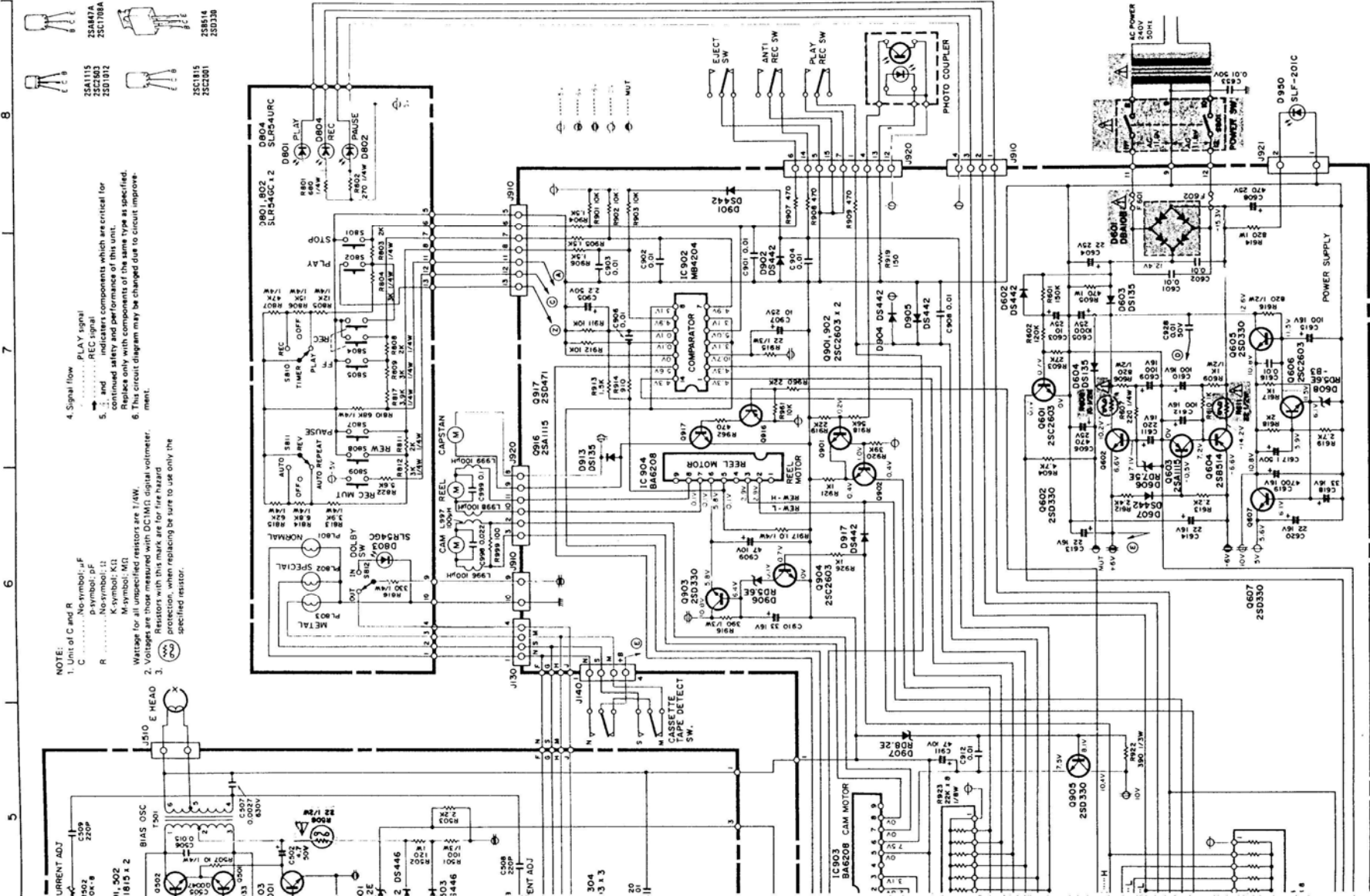

NOTE:
 1. Unit of C and R
 C No symbol, μF
 P pF
 R No symbol, Ω
 K K
 M M
 W W
 2. Voltages are those measured with DC (1M) digital voltmeter.
 3. Resistors with this mark are for fire hazard protection, when replacing be sure to use only the specified resistor.

4. Signal flow
 PLAY signal
 REC signal
 and indicators components which are critical for continued safety and performance of this unit.
 5. as specified.
 6. This circuit diagram may be changed due to circuit improvement.

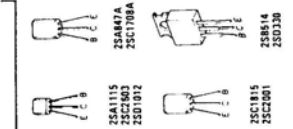

PRINTED CIRCUIT BOARDS

1 2 3 4 5

..... + B PATTERN
 - B PATTERN

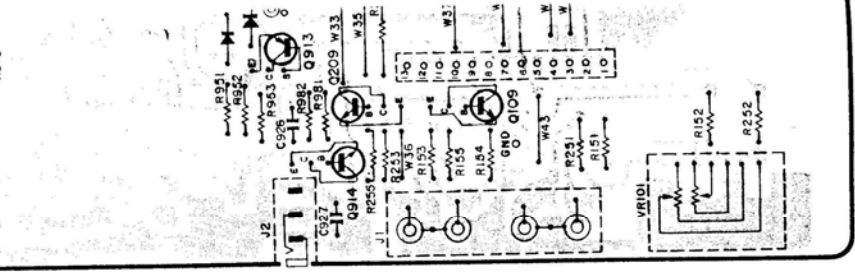
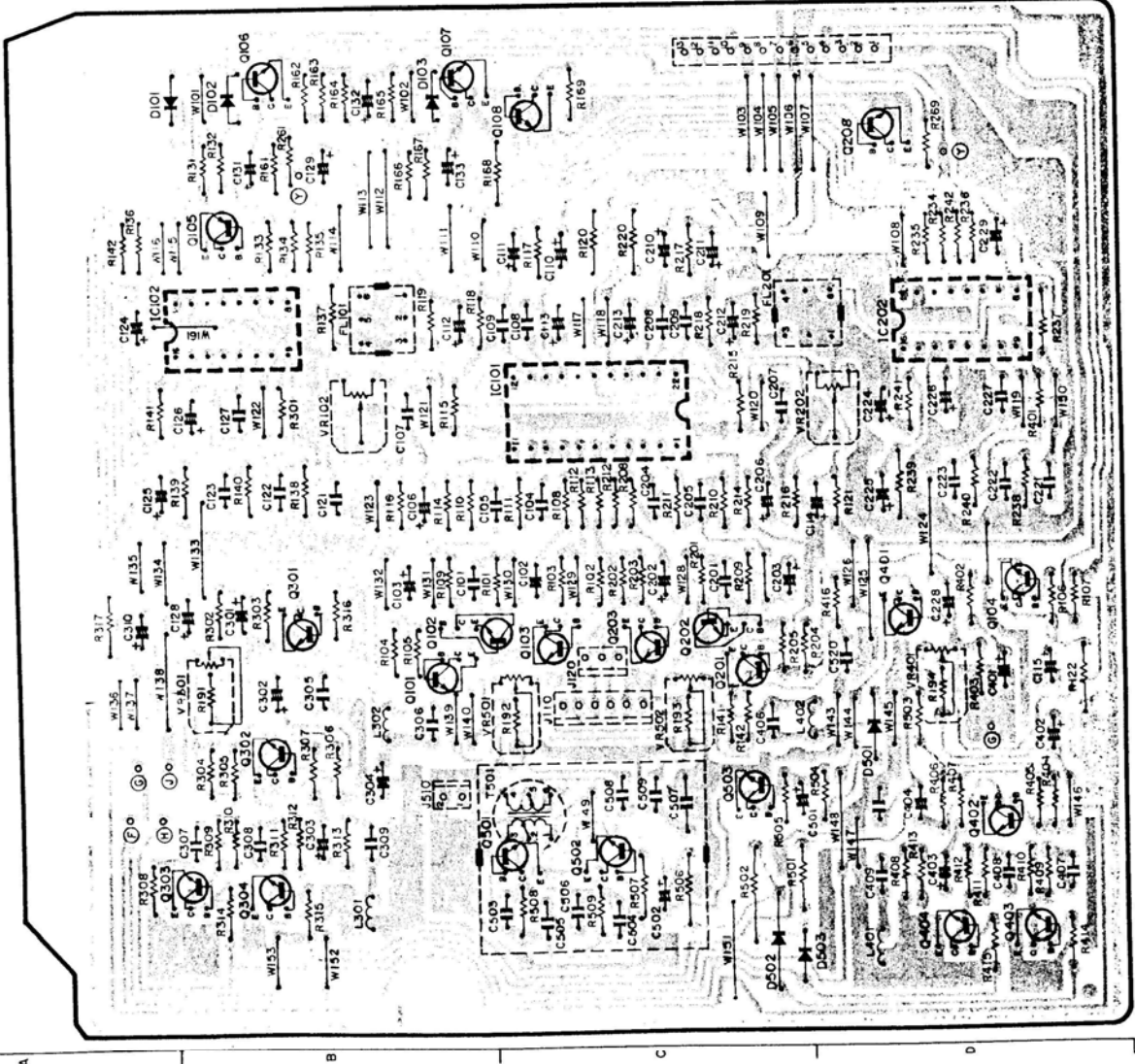
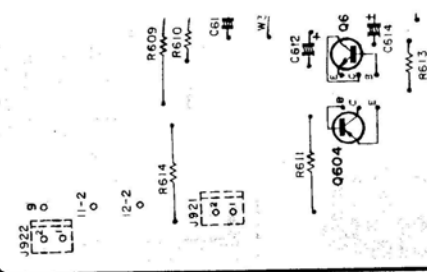

Symbol No.	Address	Symbol No.	Address	Symbol No.	Address	Symbol No.	Address	Symbol No.	Address	Symbol No.	Address	Symbol No.	Address	Symbol No.	Address
C101	B-2	C310	A-2	C603	A-6	D909	C-7	J1	C-5	Q301	B-2	Q304	C-8	R111	C
C102	C-2	C401	D-2	C604	A-6	D910	C-6	J2	C-5	Q302	B-1	Q305	B-7	R112	C
C103	C-3	C402	D-2	C605	A-6	D911	C-6	L301	B-1	Q303	B-1	Q306	C-7	R113	B
C104	C-3	C403	D-1	C606	A-7	D912	B-8	L302	B-2	Q304	B-1	Q307	C-7	R114	B
C105	B-3	C404	D-1	C607	A-6	D913	B-8	L401	D-1	Q401	D-2	Q308	B-7	R115	B
C106	B-3	C405	D-1	C608	A-6	D914	B-8	L402	C-2	Q402	D-1	Q309	C-6	R116	B
C107	B-3	C406	C-2	C609	A-6	D915	C-6	L403	C-2	Q403	D-1	Q310	C-6	R117	B
C108	C-3	C407	D-1	C610	A-6	D916	C-6	L404	C-2	Q404	D-1	Q311	C-6	R118	B
C109	C-3	C408	D-1	C611	B-6	D917	C-6	L405	C-2	Q405	D-1	Q312	D-6	R119	B
C110	C-3	C409	D-1	C612	B-6	D918	C-6	L406	C-2	Q406	D-1	Q313	C-5	R120	B
C111	C-3	C501	C-1	C613	B-6	D919	C-6	L407	C-2	Q407	D-1	Q314	C-5	R121	D
C112	B-3	C502	C-1	C614	B-6	D920	C-6	L408	C-2	Q408	D-1	Q315	C-5	R122	D
C113	C-3	C503	C-1	C615	A-7	D921	C-6	L409	C-2	Q409	D-1	Q316	C-5	R123	B
C114	D-3	C504	C-1	C616	A-7	D922	C-6	L410	C-2	Q410	D-1	Q317	C-5	R124	B
C115	D-3	C505	C-1	C617	A-7	D923	C-6	L411	C-2	Q411	D-1	Q318	C-5	R125	B
C116	D-3	C506	C-1	C618	B-6	D924	C-6	L412	C-2	Q412	D-1	Q319	C-5	R126	B
C117	C-3	C507	C-1	C619	B-6	D925	C-6	L413	C-2	Q413	D-1	Q320	C-5	R127	B
C118	C-3	C508	C-1	C620	B-6	D926	C-6	L414	C-2	Q414	D-1	Q321	C-5	R128	B
C119	C-3	C509	C-1	C621	B-6	D927	C-6	L415	C-2	Q415	D-1	Q322	C-5	R129	B
C120	C-3	C510	C-1	C622	B-6	D928	C-6	L416	C-2	Q416	D-1	Q323	C-5	R130	B
C121	B-3	C511	C-1	C623	B-6	D929	C-6	L417	C-2	Q417	D-1	Q324	C-5	R131	B
C122	B-3	C512	C-1	C624	B-6	D930	C-6	L418	C-2	Q418	D-1	Q325	C-5	R132	B
C123	B-3	C513	C-1	C625	B-6	D931	C-6	L419	C-2	Q419	D-1	Q326	C-5	R133	B
C124	A-3	C514	C-1	C626	B-6	D932	C-6	L420	C-2	Q420	D-1	Q327	C-5	R134	B
C125	A-3	C515	C-1	C627	B-6	D933	C-6	L421	C-2	Q421	D-1	Q328	C-5	R135	B
C126	B-3	C516	C-1	C628	B-6	D934	C-6	L422	C-2	Q422	D-1	Q329	C-5	R136	B
C127	B-2	C517	C-1	C629	B-6	D935	C-6	L423	C-2	Q423	D-1	Q330	C-5	R137	B
C128	B-2	C518	C-1	C630	B-6	D936	C-6	L424	C-2	Q424	D-1	Q331	C-5	R138	B
C129	B-4	C519	C-1	C631	B-6	D937	C-6	L425	C-2	Q425	D-1	Q332	C-5	R139	B
C130	A-2	C520	C-1	C632	B-6	D938	C-6	L426	C-2	Q426	D-1	Q333	C-5	R140	B
C131	B-4	C521	C-1	C633	B-6	D939	C-6	L427	C-2	Q427	D-1	Q334	C-5	R141	B
C132	B-4	C522	C-1	C634	B-6	D940	C-6	L428	C-2	Q428	D-1	Q335	C-5	R142	A
C133	B-4	C523	C-1	C635	B-6	D941	C-6	L429	C-2	Q429	D-1	Q336	C-5	R143	A
C134	B-4	C524	C-1	C636	B-6	D942	C-6	L430	C-2	Q430	D-1	Q337	C-5	R144	A
C201	C-2	C525	C-1	C637	B-6	D943	C-6	L431	C-2	Q431	D-1	Q338	C-5	R145	A
C202	C-2	C526	C-1	C638	B-6	D944	C-6	L432	C-2	Q432	D-1	Q339	C-5	R146	A
C203	C-3	C527	C-1	C639	B-6	D945	C-6	L433	C-2	Q433	D-1	Q340	C-5	R147	A
C204	C-3	C528	C-1	C640	B-6	D946	C-6	L434	C-2	Q434	D-1	Q341	C-5	R148	A
C205	C-3	C529	C-1	C641	B-6	D947	C-6	L435	C-2	Q435	D-1	Q342	C-5	R149	A
C206	C-3	C530	C-1	C642	B-6	D948	C-6	L436	C-2	Q436	D-1	Q343	C-5	R150	A
C207	C-3	C531	C-1	C643	B-6	D949	C-6	L437	C-2	Q437	D-1	Q344	C-5	R151	A
C208	C-3	C532	C-1	C644	B-6	D950	C-6	L438	C-2	Q438	D-1	Q345	C-5	R152	A
C209	C-3	C533	C-1	C645	B-6	D951	C-6	L439	C-2	Q439	D-1	Q346	C-5	R153	A
C210	C-3	C534	C-1	C646	B-6	D952	C-6	L440	C-2	Q440	D-1	Q347	C-5	R154	A
C211	C-3	C535	C-1	C647	B-6	D953	C-6	L441	C-2	Q441	D-1	Q348	C-5	R155	A
C212	B-3	C536	C-1	C648	B-6	D954	C-6	L442	C-2	Q442	D-1	Q349	C-5	R156	A
C213	B-3	C537	C-1	C649	B-6	D955	C-6	L443	C-2	Q443	D-1	Q350	C-5	R157	A
C214	A-3	C538	C-1	C650	B-6	D956	C-6	L444	C-2	Q444	D-1	Q351	C-5	R158	A
C215	A-3	C539	C-1	C651	B-6	D957	C-6	L445	C-2	Q445	D-1	Q352	C-5	R159	A

DT-41P DT-41P

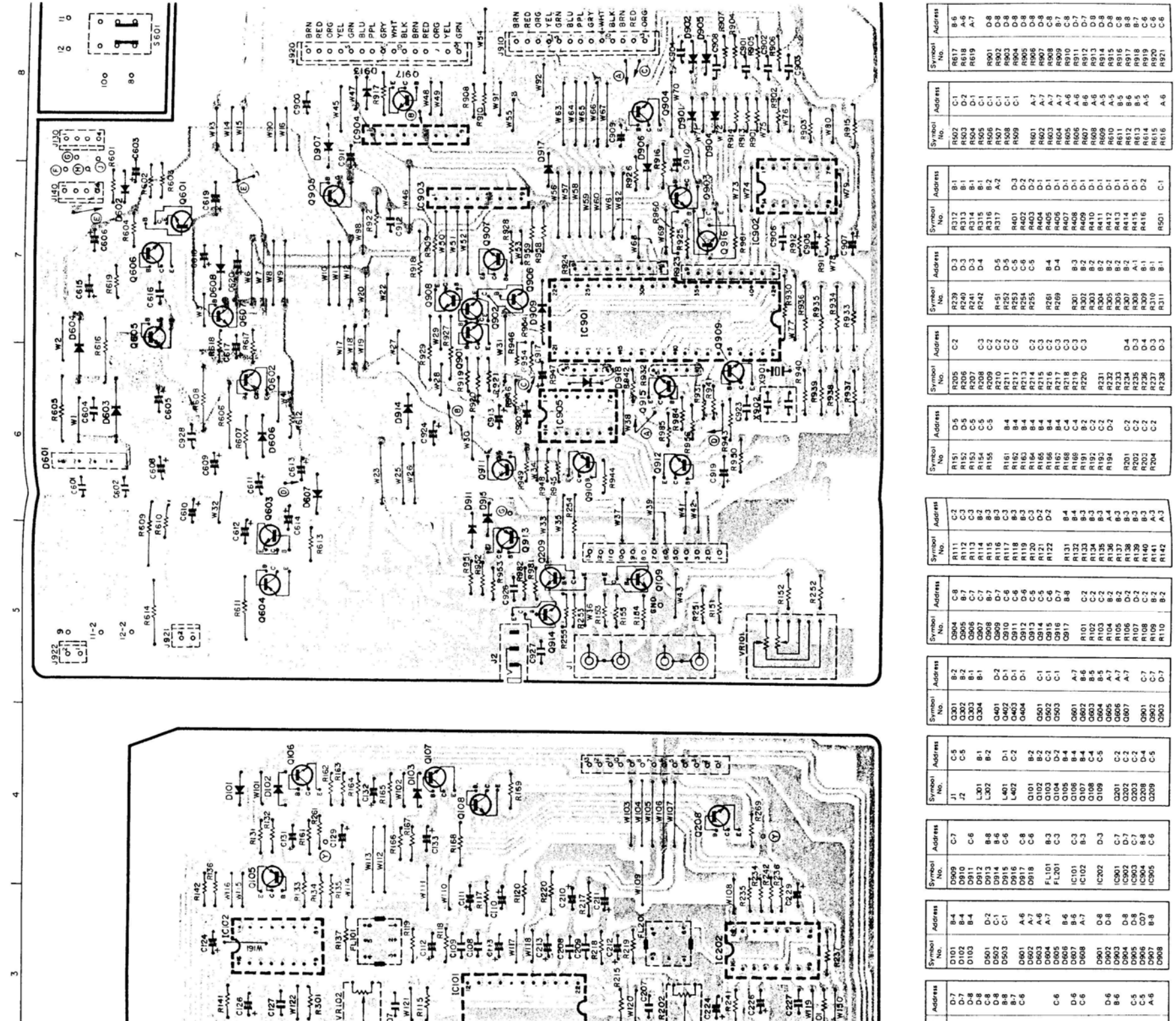

3 4 5 6 7 8

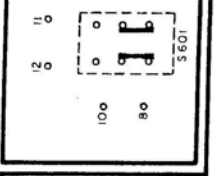

Symbol No.	D-7	D-8	C-8	D-8	B-2	Q-201	Q-202	Q-203	Q-401	Q-402	Q-403	Q-404	Q-501	Q-502	Q-503	Q-601	Q-602	Q-603	Q-604	Q-605	Q-606	Q-607	Q-801	Q-802	Q-803	Q-804	Q-805
Address	D-7	D-8	C-8	D-8	B-2	C-5	B-1	B-1	D-2	D-1	D-1	C-1	C-1	C-1	C-1	A-7	B-5	B-5	A-7	A-7	A-7	A-7	C-2	C-2	C-2	D-4	C-5
Symbol No.	D-9	D-10	D-11	D-12	D-13	J-1	J-2	L-201	L-202	L-203	L-204	L-205	Q-101	Q-102	Q-103	Q-104	Q-105	Q-106	Q-107	Q-108	Q-109	Q-201	Q-202	Q-203	Q-204	Q-205	Q-206
Address	D-9	D-10	D-11	D-12	D-13	C-7	C-6	B-8	B-8	B-8	B-8	B-8	B-2	B-2	B-2	B-4	B-4	B-4	B-4	B-3	B-3	D-3	C-7	C-7	C-7	B-8	C-6
Symbol No.	D-14	D-15	D-16	D-17	D-18	D-19	D-20	D-21	D-22	D-23	D-24	D-25	D-26	D-27	D-28	D-29	D-30	D-31	D-32	D-33	D-34	D-35	D-36	D-37	D-38	D-39	D-40
Address	D-14	D-15	D-16	D-17	D-18	D-19	D-20	D-21	D-22	D-23	D-24	D-25	D-26	D-27	D-28	D-29	D-30	D-31	D-32	D-33	D-34	D-35	D-36	D-37	D-38	D-39	D-40
Symbol No.	D-41	D-42	D-43	D-44	D-45	D-46	D-47	D-48	D-49	D-50	D-51	D-52	D-53	D-54	D-55	D-56	D-57	D-58	D-59	D-60	D-61	D-62	D-63	D-64	D-65	D-66	D-67
Address	D-41	D-42	D-43	D-44	D-45	D-46	D-47	D-48	D-49	D-50	D-51	D-52	D-53	D-54	D-55	D-56	D-57	D-58	D-59	D-60	D-61	D-62	D-63	D-64	D-65	D-66	D-67
Symbol No.	D-68	D-69	D-70	D-71	D-72	D-73	D-74	D-75	D-76	D-77	D-78	D-79	D-80	D-81	D-82	D-83	D-84	D-85	D-86	D-87	D-88	D-89	D-90	D-91	D-92	D-93	D-94
Address	D-68	D-69	D-70	D-71	D-72	D-73	D-74	D-75	D-76	D-77	D-78	D-79	D-80	D-81	D-82	D-83	D-84	D-85	D-86	D-87	D-88	D-89	D-90	D-91	D-92	D-93	D-94
Symbol No.	D-95	D-96	D-97	D-98	D-99	D-100	D-101	D-102	D-103	D-104	D-105	D-106	D-107	D-108	D-109	D-110	D-111	D-112	D-113	D-114	D-115	D-116	D-117	D-118	D-119	D-120	D-121
Address	D-95	D-96	D-97	D-98	D-99	D-100	D-101	D-102	D-103	D-104	D-105	D-106	D-107	D-108	D-109	D-110	D-111	D-112	D-113	D-114	D-115	D-116	D-117	D-118	D-119	D-120	D-121
Symbol No.	D-122	D-123	D-124	D-125	D-126	D-127	D-128	D-129	D-130	D-131	D-132	D-133	D-134	D-135	D-136	D-137	D-138	D-139	D-140	D-141	D-142	D-143	D-144	D-145	D-146	D-147	D-148
Address	D-122	D-123	D-124	D-125	D-126	D-127	D-128	D-129	D-130	D-131	D-132	D-133	D-134	D-135	D-136	D-137	D-138	D-139	D-140	D-141	D-142	D-143	D-144	D-145	D-146	D-147	D-148
Symbol No.	D-149	D-150	D-151	D-152	D-153	D-154	D-155	D-156	D-157	D-158	D-159	D-160	D-161	D-162	D-163	D-164	D-165	D-166	D-167	D-168	D-169	D-170	D-171	D-172	D-173	D-174	D-175
Address	D-149	D-150	D-151	D-152	D-153	D-154	D-155	D-156	D-157	D-158	D-159	D-160	D-161	D-162	D-163	D-164	D-165	D-166	D-167	D-168	D-169	D-170	D-171	D-172	D-173	D-174	D-175
Symbol No.	D-176	D-177	D-178	D-179	D-180	D-181	D-182	D-183	D-184	D-185	D-186	D-187	D-188	D-189	D-190	D-191	D-192	D-193	D-194	D-195	D-196	D-197	D-198	D-199	D-200	D-201	D-202
Address	D-176	D-177	D-178	D-179	D-180	D-181	D-182	D-183	D-184	D-185	D-186	D-187	D-188	D-189	D-190	D-191	D-192	D-193	D-194	D-195	D-196	D-197	D-198	D-199	D-200	D-201	D-202
Symbol No.	D-203	D-204	D-205	D-206	D-207	D-208	D-209	D-210	D-211	D-212	D-213	D-214	D-215	D-216	D-217	D-218	D-219	D-220	D-221	D-222	D-223	D-224	D-225	D-226	D-227	D-228	D-229
Address	D-203	D-204	D-205	D-206	D-207	D-208	D-209	D-210	D-211	D-212	D-213	D-214	D-215	D-216	D-217	D-218	D-219	D-220	D-221	D-222	D-223	D-224	D-225	D-226	D-227	D-228	D-229
Symbol No.	D-230	D-231	D-232	D-233	D-234	D-235	D-236	D-237	D-238	D-239	D-240	D-241	D-242	D-243	D-244	D-245	D-246	D-247	D-248	D-249	D-250	D-251	D-252	D-253	D-254	D-255	D-256
Address	D-230	D-231	D-232	D-233	D-234	D-235	D-236	D-237	D-238	D-239	D-240	D-241	D-242	D-243	D-244	D-245	D-246	D-247	D-248	D-249	D-250	D-251	D-252	D-253	D-254	D-255	D-256
Symbol No.	D-257	D-258	D-259	D-260	D-261	D-262	D-263	D-264	D-265	D-266	D-267	D-268	D-269	D-270	D-271	D-272	D-273	D-274	D-275	D-276	D-277	D-278	D-279	D-280	D-281	D-282	D-283
Address	D-257	D-258	D-259	D-260	D-261	D-262	D-263	D-264	D-265	D-266	D-267	D-268	D-269	D-270	D-271	D-272	D-273	D-274	D-275	D-276	D-277	D-278	D-279	D-280	D-281	D-282	D-283
Symbol No.	D-284	D-285	D-286	D-287	D-288	D-289	D-290	D-291	D-292	D-293	D-294	D-295	D-296	D-297	D-298	D-299	D-300	D-301	D-302	D-303	D-304	D-305	D-306	D-307	D-308	D-309	D-310
Address	D-284	D-285	D-286	D-287	D-288	D-289	D-290	D-291	D-292	D-293	D-294	D-295	D-296	D-297	D-298	D-299	D-300	D-301	D-302	D-303	D-304	D-305	D-306	D-307	D-308	D-309	D-310
Symbol No.	D-311	D-312	D-313	D-314	D-315	D-316	D-317	D-318	D-319	D-320	D-321	D-322	D-323	D-324	D-325	D-326	D-327	D-328	D-329	D-330	D-331	D-332	D-333	D-334	D-335	D-336	D-337
Address	D-311	D-312	D-313	D-314	D-315	D-316	D-317	D-318	D-319	D-320	D-321	D-322	D-323	D-324	D-325	D-326	D-327	D-328	D-329	D-330	D-331	D-332	D-333	D-334	D-335	D-336	D-337
Symbol No.	D-338	D-339	D-340	D-341	D-342	D-343	D-344	D-345	D-346	D-347	D-348	D-349	D-350	D-351	D-352	D-353	D-354	D-355	D-356	D-357	D-358	D-359	D-360	D-361	D-362	D-363	D-364
Address	D-338	D-339	D-340	D-341	D-342	D-343	D-344	D-345	D-346	D-347	D-348	D-349	D-350	D-351	D-352	D-353	D-354	D-355	D-356	D-357	D-358	D-359	D-360	D-361	D-362	D-363	D-364
Symbol No.	D-365	D-366	D-367	D-368	D-369	D-370	D-371	D-372	D-373	D-374	D-375	D-376	D-377	D-378	D-379	D-380	D-381	D-382	D-383	D-384	D-385	D-386	D-387	D-388	D-389	D-390	D-391
Address	D-365	D-366	D-367	D-368	D-369	D-370	D-371	D-372	D-373	D-374	D-375	D-376	D-377	D-378	D-379	D-380	D-381	D-382	D-383	D-384	D-385	D-386	D-387	D-388	D-389	D-390	D-391
Symbol No.	D-392	D-393	D-394	D-395	D-396	D-397	D-398	D-399	D-400	D-401	D-402	D-403	D-404	D-405	D-406	D-407	D-408	D-409	D-410	D-411	D-412	D-413	D-414	D-415	D-416	D-417	D-418
Address	D-392	D-393	D-394	D-395	D-396	D-397	D-398	D-399	D-400	D-401	D-402	D-403	D-404	D-405	D-406	D-407	D-408	D-409	D-410	D-411	D-412	D-413	D-414	D-415	D-416	D-417	D-418
Symbol No.	D-419	D-420	D-421	D-422	D-423	D-424	D-425	D-426	D-427	D-428	D-429	D-430	D-431	D-432	D-433	D-434	D-435	D-436	D-437	D-438	D-439	D-440	D-441	D-442	D-443	D-444	D-445
Address	D-419	D-420	D-421	D-422	D-423	D-424	D-425	D-426	D-427	D-428	D-429	D-430	D-431	D-432	D-433	D-434	D-435	D-436	D-437	D-438	D-439	D-440	D-441	D-442	D-443	D-444	D-445
Symbol No.	D-446	D-447	D-448	D-449	D-450	D-451	D-452	D-453	D-454	D-455	D-456	D-457	D-458	D-459	D-460	D-461	D-462	D-463	D-464	D-465	D-466	D-467	D-468	D-469	D-470	D-471	D-472
Address	D-446	D-447	D-448	D-449	D-450	D-451	D-452	D-453	D-454	D-455	D-456	D-457	D-458	D-459	D-460	D-461	D-462	D-463	D-464	D-465	D-466	D-467	D-468	D-469	D-470	D-471	D-472
Symbol No.	D-473	D-474	D-475	D-476	D-477	D-478	D-479	D-480	D-481	D-482	D-483	D-484	D-485	D-486	D-487	D-488	D-489	D-490	D-491	D-492	D-493	D-494	D-495	D-496	D-497	D-498	D-499
Address	D-473	D-474	D-475	D-476	D-477	D-478	D-479	D-480	D-481	D-482	D-483	D-484	D-485	D-486	D-487	D-488	D-489	D									

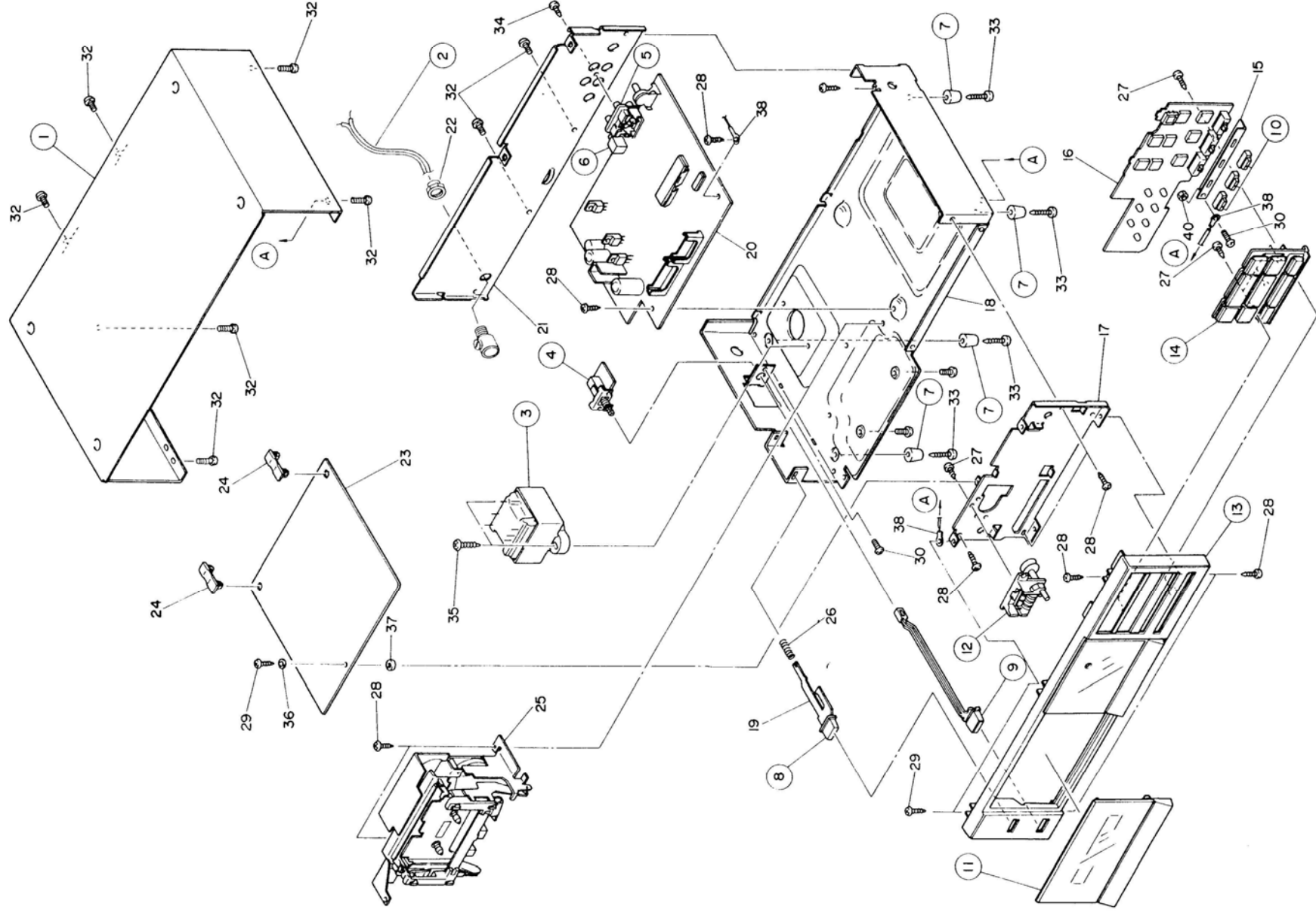

EXPLODED VIEW OF CABINET



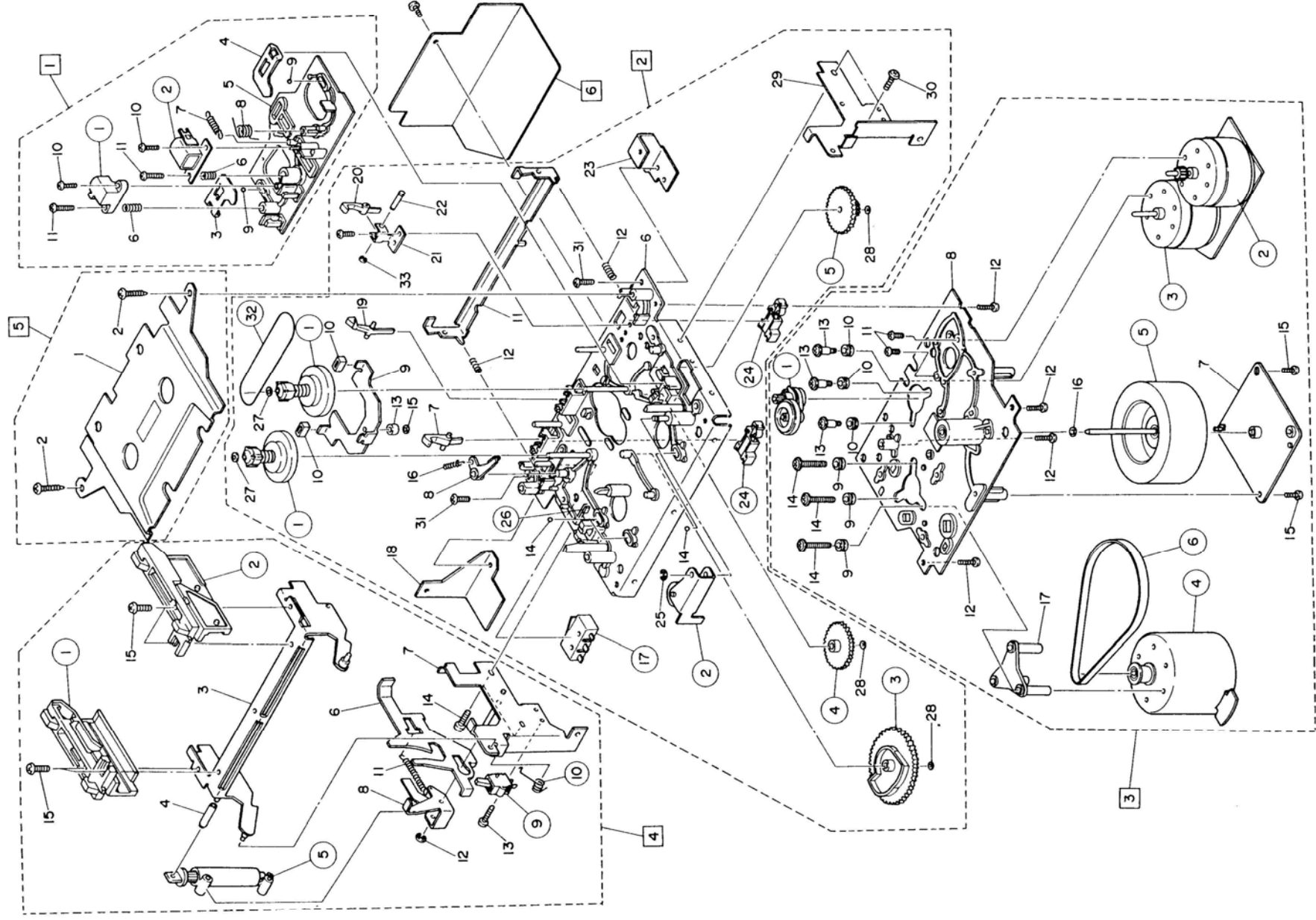







EXPLODED VIEW OF MECHANISM



PARTS LIST

NOTE:  and  marks components on Parts list have special characteristics to keep safety performance of this unit. When replacing any of these parts, be sure to use only specified parts.

Symbol No.	Part No.	Description
Cabinet		
1	M05237162	Case (Top cover)
2	M07556490	Power cord
3	M05247500	Trans-Power
4	M04174357	SW-Power
5	M04172480	Terminal (Line, Out/In)
6	M05237475	Jack (Auto Function)
7	M05237190	Leg
8	M05237201	Knob (Eject)
9	M05211205	Knob (Power)
10	M05237200	Knob (Auto, Timer, Dolby)
11	M05245132	Cover Ass'y (Cassette)
12	M05206404	Counter
13	M05245100	Panel Ass'y (Front)
14	M05245200	Knob (Mechanism Control)
15		Holder
16		Mechanism Control P.C.B.
17		Panel-Front
18		Chassis Base
19		Link
20		Main P.C.B.
21		Back Panel
22	M07535060	Clamper
23		
24		Hinge
25		Mechanism Ass'y
26		Spring
27		Screw 1-2.6 x 6
28		Screw 2-3 x 6
29		Screw 2-3 x 8
30		Screw M3 x 6
31		
32		Screw M3 x 8 (V)
33		Screw 2-3 x 16
34		Screw 1-3 x 8
35		Screw 2-4 x 16
36		Washer
37		Rubber Cushion
38		Lug-terminal
39		
40		Nut M3
41		Clamper
Mechanical Parts		
		Head Base Ass'y
		Chassis Ass'y
		Motor Base Ass'y
		Eject Mechanism Ass'y
		Holder
		Shield
		Head Base Ass'y
1	M04172524	Erase Head
2	M04172520	Rec/PB Head
3		Plate Spring (Stopper L)
4		Plate Spring (Stopper R)

Symbol No.	Part No.	Description
5		Head Base
6		Spring (Head)
7		Spring (Head)
8		Spring (Pinch Roller)
9	M07314627	Steel Ball
10		Screw 1-2 x 8
11		Screw M2 x 4
		Chassis Base Ass'y
1	M05232702	Reel Rest Ass'y
2	M05232720	Pinch Roller
3	M05232732	Main Gear
4	M05232730	Gear (Centre)
5	M05232731	Gear (Centre)
6		Chassis Base Ass'y
7		Lever (AR)
8		Lever (Back Tension)
9		Link (Blerk)
10		Rubber Cushion
11		Holder (Cassette Stopper)
12		Spring
13		Pulley
14	M05021627	Steel Ball
15		PL Washer
16		Spring (Back Tension)
17	M07602381	Micro SW (AR)
18		Holder L
19		Lever (Tape Auto Select)
20		Lever (Tape Auto Select)
21		Holder
22		Pin
23		Holder U
24	M05202435	Micro SW (Tape Auto Select)
25		E-ring
26	M05208390	Spring SW
27		PL Washer
28		PL Washer
29		Holder
30		Screw 2-3 x 6
31		Screw 2-3 x 8
32		Counter Belt
33	M05237713	E-ring 2
		Motor Base Ass'y
1	M05232632	Pulley Ass'y (FF/REW)
2	M05232552	Cam Motor
3	M05232551	Reel Motor
4	M05232550	Capstan Motor
5	M05232756	Flywheel
6	M05232713	Main Belt
7		Holder (for Fly Wheel)
8		Motor Base
9		Rubber Cushion (Capstan Motor)
10		Rubber Cushion (Reel Motor)
11		Screw M2.6 x 5
12		Screw-B 2.6 x 14
13		Screw M2.6 x 5
14		Screw M2.6 x 25
15		Screw 1-2.6 x 8
16		PL Washer

Symbol No.	Part No.	Description
17		Holder (for Motor)
[4]		Eject Mechanism Ass'y
1	M05207148	Holder (L)
2	M05207147	Holder (R)
3		Cassette Holder
4		Spacer
5	M041655625	Damper
6		Link
7		Holder
8		Lever
9	M05237380	Micro-SW
10	M05237760	Spring
11		Spring 2
12		E-ring 2
13		Screw M2 x 8
14		Screw 2-3 x 6
15		Screw 2-2.6 x 5
[5]		Holder
1		Holder
2		Screw B 2.6 x 14

Symbol No.	Part No.	Description
Diodes		
D101	M07556320	DS442
D102	M07556320	DS442
D103	M07556320	DS442
D501	M05232327	RD8.2E-B2
D502	M07556320	DS442
D503		DS446
D601	M05223320	DBA10B
D602	M07556320	DS442
D603	M07568320	DS135
D604	M07568320	DS135
D606	M05232326	RD7.5E-B1
D607	M07556320	DS442
D608	M05232331	RD5.6E-B3
D801	M07460321	SLR54GC
D802	M07460321	SLR54GC
D803	M07460321	SLR54GC
D804	M07520326	SLR54URC
D901	M07556320	DS442
D902	M07556320	DS442
D903		
D904	M07556320	DS442
D905	M07556320	DS442
D906	M05232329	RD5.6E-B1
D907	M05232327	RD8.2E-B2
D909	M07556320	DS442
D911	M07556320	DS442
D913	M07568320	DS135
D915	M07556320	DS442
D917	M07556320	DS442
D918	M07556320	DS442
D931	M07556320	DS442
D932	M07556320	DS442
D933	M07556320	DS442
D934	M07556320	DS442
D950	M05237320	SLF-201C
ICs		
IC101	M05237310	M51125P
IC102	M05225314	TA7629P
IC202	M05225314	TA7629P
TC901	M05232312	MB8841-584K
IC902	M05232313	MB4204
IC903	M07568310	BA6208
IC904	M07568310	BA6208
IC905	M05232314	M54527P
Transistors		
Q101	M07113310	2SC1708A
Q102	M07113310	2SC1708A
Q103	M07390303	2SC2603
Q104	M07140303	2SA847A
Q105	M07390304	2SA1115

Symbol No.	Part No.	Description
Q106	M07390303	2SC2603
Q107	M07390303	2SC2603
Q108	M07390303	2SC2603
Q109	M07390303	2SC2603
Q201	M07113310	2SC1708A:
Q202	M07113310	2SC1708A
Q203	M07390303	2SC2603
Q208	M07390303	2SC2603
Q209	M07390303	2SC2603
Q301	M07454303	2SD1012
Q302	M07390303	2SC2603
Q303	M07390303	2SC2603
Q304	M07390303	2SC2603
Q401	M07454303	2SD1012
Q402	M07390303	2SC2603
Q403	M07390303	2SC2603
Q404	M07390303	2SC2603
Q501	M05237300	2SC1815
Q502	M07314303	2SC2001
Q601	M07390303	2SC2603
Q602	M07061304	2SD330
Q603	M07390304	2SA1115
Q604	M05200310	2SB514
Q605	M07061304	2SD330
Q606	M07390303	2SC2603
Q607	M07061304	2SD330
Q901	M07390303	2SC2603
Q902	M07390303	2SC2603
Q903	M07061304	2SD330
Q904	M07061304	2SD330
Q905	M07061304	2SD330
Q906	M07390303	2SC2603
Q907	M07390303	2SC2603
Q908	M07390303	2SC2603
Q909	M07390303	2SC2603
Q910	M07390304	2SA1115
Q911	M07390304	2SA1115
Q912	M07390303	2SC2603
Q913	M07390304	2SA1115
Q914	M07390303	2SC2603
Q915	M07390303	2SC2603
Q916	M07390304	2SC1115
Q917	M05147311	2SD471
Q931	M07390303	2SC2603
Q932	M07390303	2SC2603
	M07508303	NJL5141EA
Electrical Parts		
L301	M05237510	Coil 4.7mH
L302	M05209420	Coil 22mH
L401	M05237510	Coil 4.7mH
L402	M05209420	Coil 22mH
T501	M05237511	Coil OSC
R505	M07139411	RF-OSC 1/2W 22K
R506	M07139420	RF-Fuse 1/2W 10K
R511	M07139411	RF-Fuse 1/2W 22K

Symbol No.	Part No.	Description
S801	M04174357	SW-Push (POWER)
S801	M07520454	SW-Push (STOP)
S802	M07520454	SW-Push (PLAY)
S804	M05237355	SW-Push (REC)
S805	M07520454	SW-Push (FF)
S807	M07520454	SW-Push (PAUSE)
S808	M07520454	SW-Push (REW)
S809	M07520454	SW-Push (REC MUT)
S810	M05202434	SW-Slide (TIMER)
S811	M05202434	SW-Slide (AUTO-REW/REPEAT)
S812	M05237360	SW-Slide (DOLBY)
PL801	M05237565	Lamp
PL802	M05237565	Lamp
PL803	M05237565	Lamp
VR101	M05237400	VR-W-A20K25
VR102	M05245410	VR-Semi-B22K
VR202	M05245410	VR-Semi-B22K
VR301	M05245411	VR-Semi-B100K
VR401	M05245411	VR-Semi-B100K
VR501	M05245411	VR-Semi-B100K
VR601	M05245411	VR-Semi-B100K
C619	M05245430	C-Elect-16V 4700μF
C605	M07546430	C-Elect-25V 1000μF
X901	M05237422	Ceramic-OSC
X902	M05237423	Ceramic-OSC
FL101	M05245445	Filter
FL201	M05245445	Filter
F601	M05110471	Fuse-800mA-Semco
F602	M05110471	Fuse-800mA-Semco
	M07508303	Photo-REF NJL5141EA
Packing		
201	M05237910	Cushion-Mold (2pcs/set)
202	M05245900	Packing Box
203	M05237930	Cover (for Packing)
	M05247940	Instruction Booklet
	M05237495	Lead (Pin-Pin)
	M05237496	Lead (Pin-Pin-Auto)
	M05247945	Card (Warranty)

BLOCK DIAGRAM

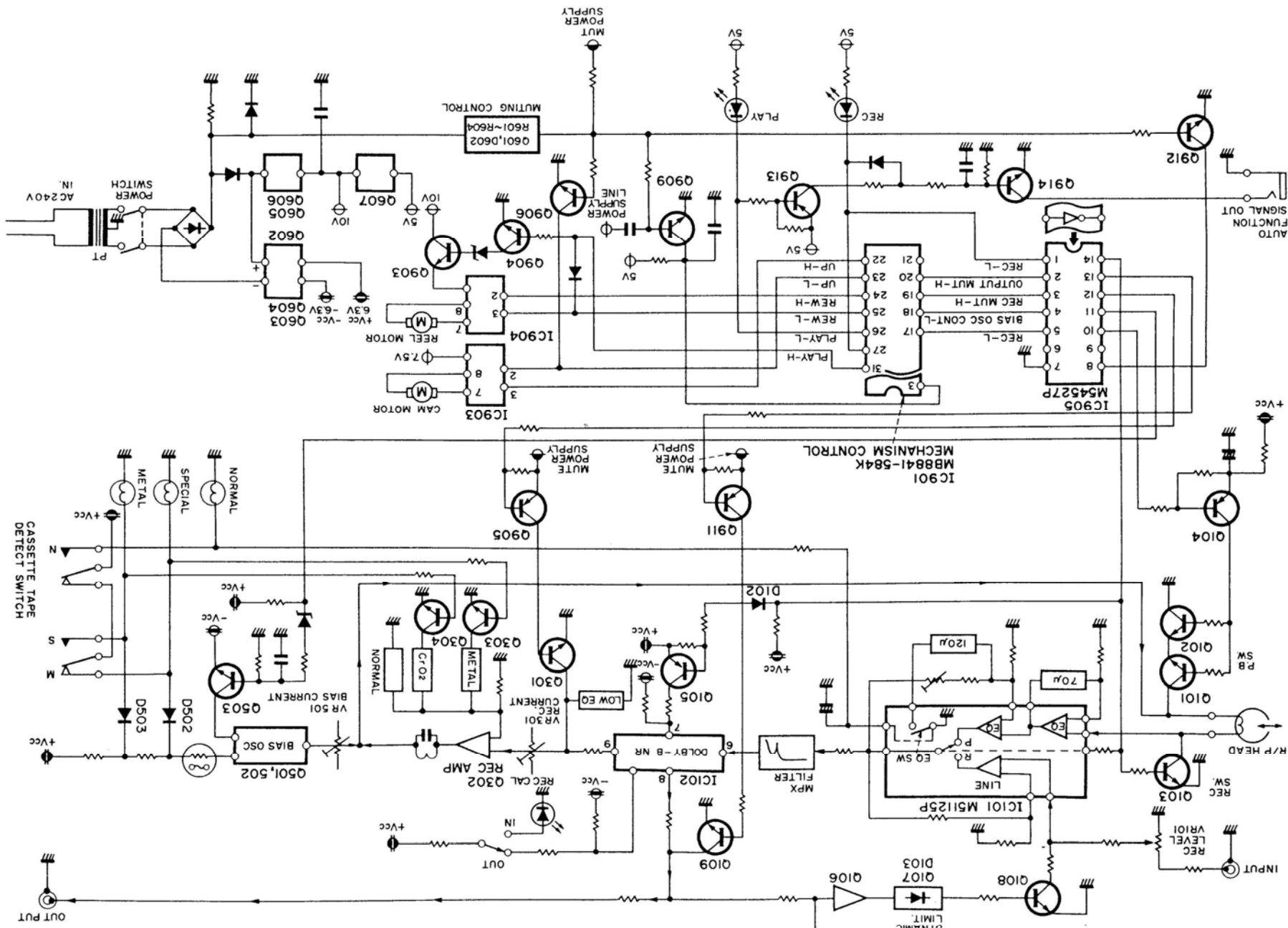

PACKING INSTRUCTIONS

